



Serving you since 1948

Transient Simulation

Capacitor Banks:

10 MVAR / 13.8 kV, 60 Hz
10 MVAR / 25 kV, 60 Hz

Prepared by:

Carlos Reinel
Senior Engineer
R&D Department
Power Survey International

Approved by:

Pierre Archambault, PEng.
VP Engineering
Power Survey International Inc.

2 December 2009

ATP Simulation – Project:

Power Survey International Inc.
7880, Trans-Canada Hwy
St-Laurent, QC
H4T 1A5

Tel. : (514) 333-8392
Fax : (514) 333-8395
e-mail: parchambault@powersurvey.com
Web site : www.powersurvey.com

TABLE OF CONTENTS

1	General
2	10 MVAR 13.8 kV, 60 Hz Capacitor Bank, 500 MVA sc
3	10 MVAR 13.8 kV, 60 Hz Capacitor Bank, 1000 MVA sc
4	10 MVAR 25 kV, 60 Hz Capacitor Bank, 500 MVA sc
5	10 MVAR 25 kV, 60 Hz Capacitor Bank, 1000 MVA sc
6	Conclusions

1. General

The simulated capacitor banks are 10 MVAR / 13.8 kV and 10 MVAR / 25 kV. The simulation has been implemented using ATP.

Utility

500 MVA and 1000 MVA sc capacity

Load

Lump load: equivalent resistors and reactors were included. The lump load was assumed to be 25 MW at 0.9 PF.

Capacitors

10 MVAR effective at 13.8 and 25 kV, including cables and busses reactance estimated at 25 μ H

Contacts Timing

Main Contacts:

Phase A at t = 1 ms

Phase B at t = 2 ms

Phase C at t = 3 ms

Resistor By-Pass Contacts:

Phase A at t = 5 ms

Phase B at t = 6 ms

Phase C at t = 7 ms

2. Capacitor Bank 10 MVAR 13.8kV / 60Hz, 500 MVA sc

Simulation Circuit

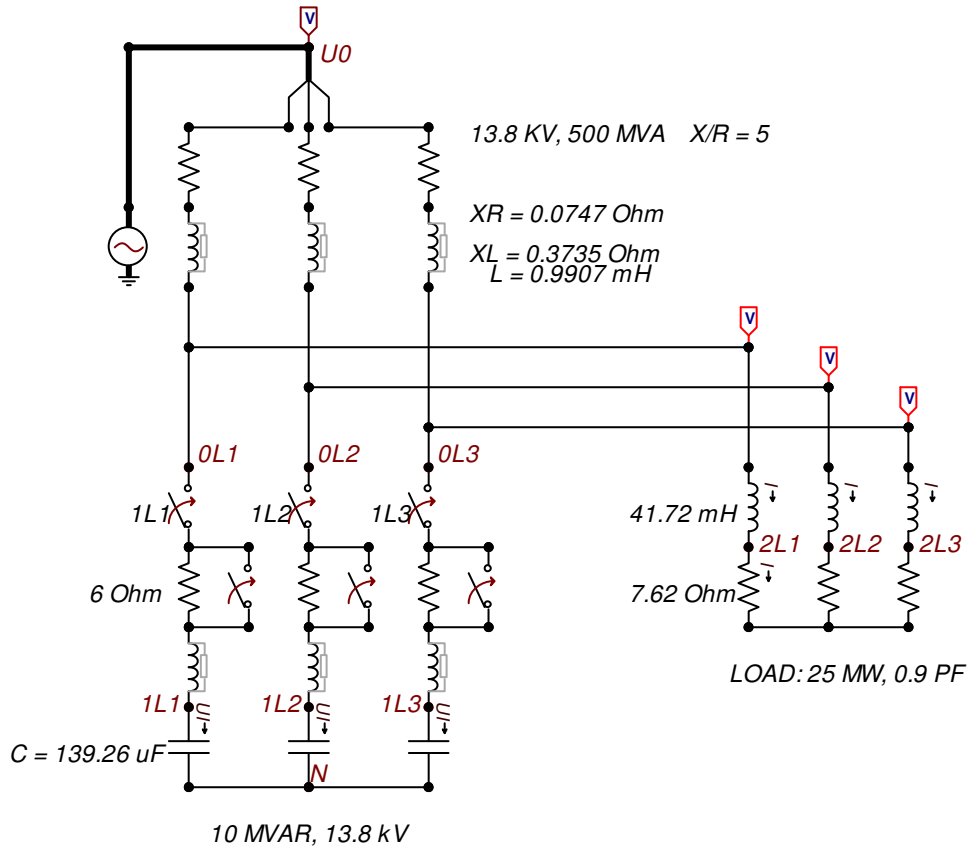

Results

Capacitor Currents without Insertion Resistors

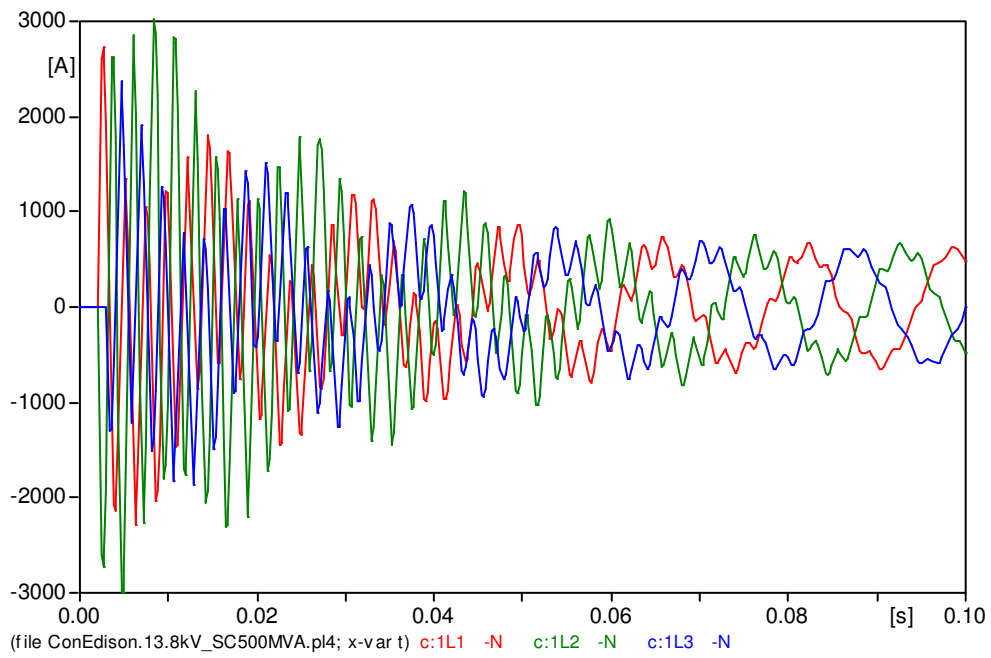

Bus Voltages without Insertion Resistors

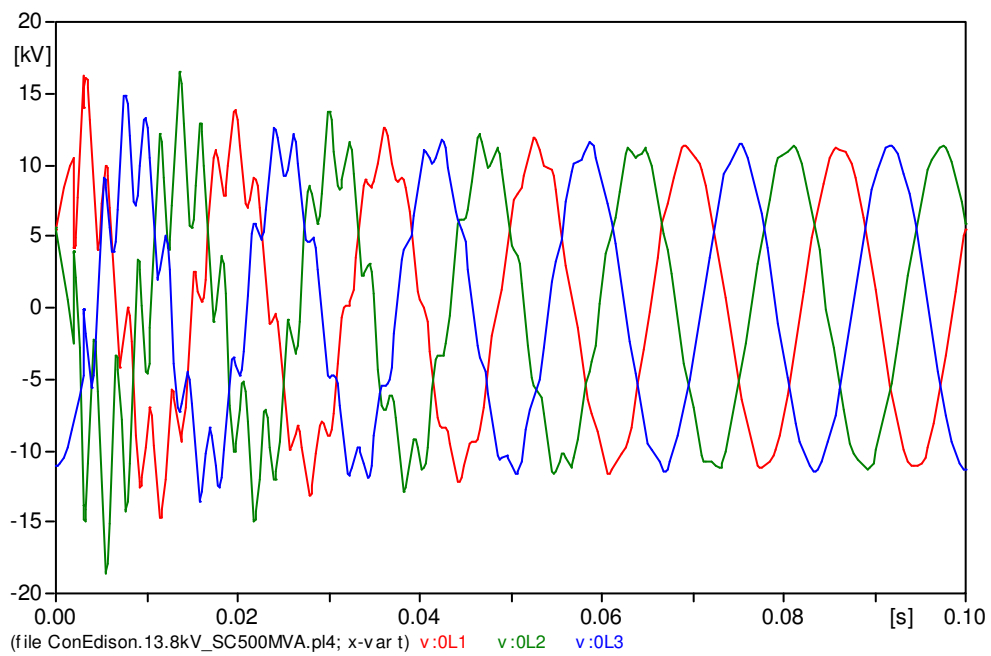

Capacitor Currents with 4 Ohm Insertion Resistors

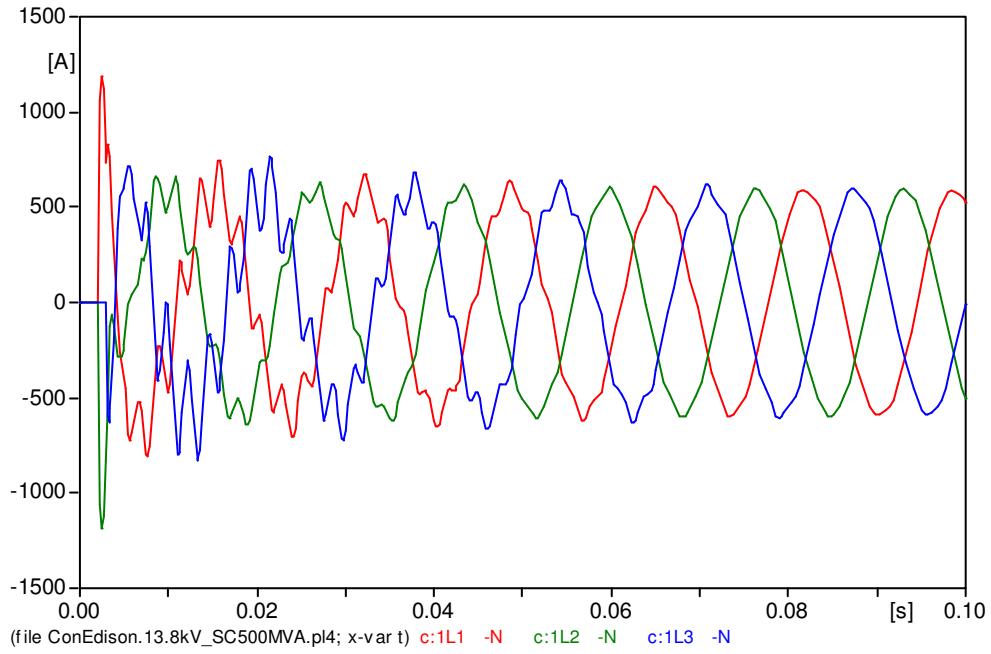

Bus Voltages with 4 Ohm Insertion Resistors

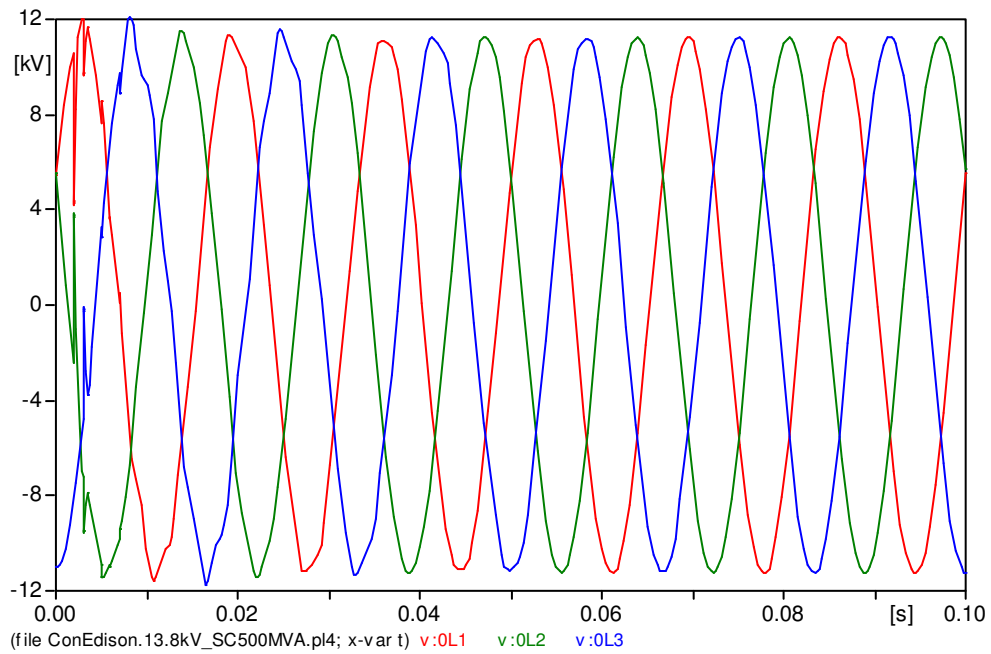

Capacitor Currents with 6 Ohm Insertion Resistors

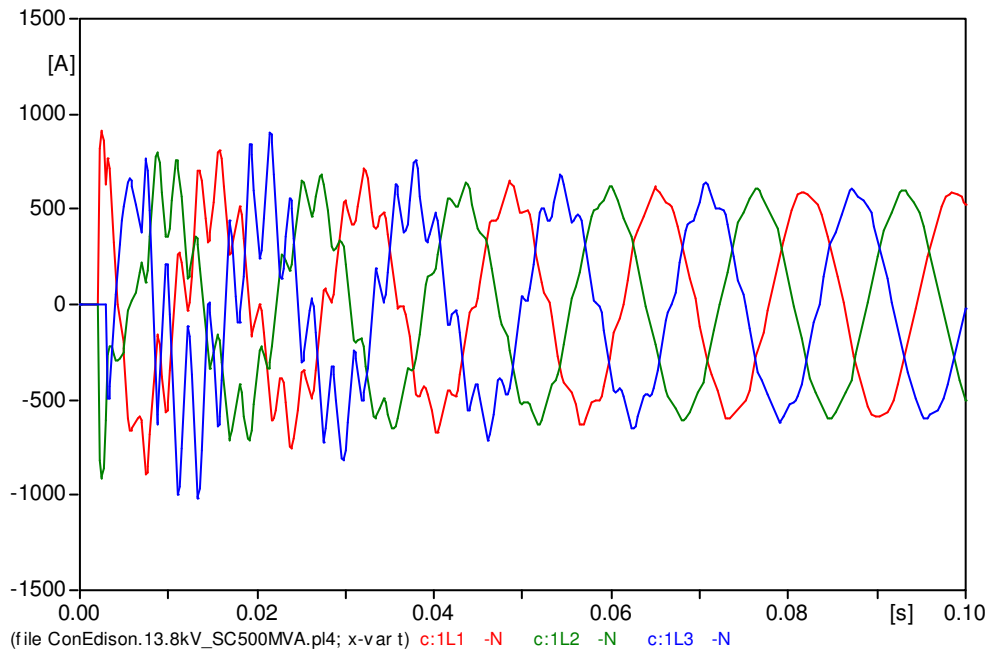

Bus Voltages with 6 Ohm Insertion Resistors

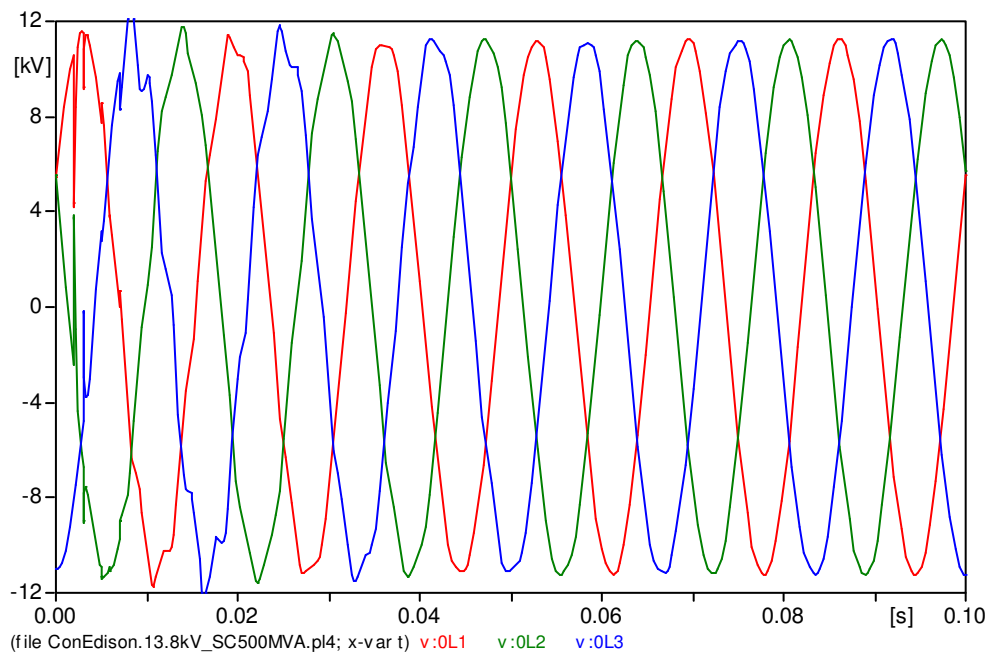

Capacitor Currents with 8 Ohm Insertion Resistors

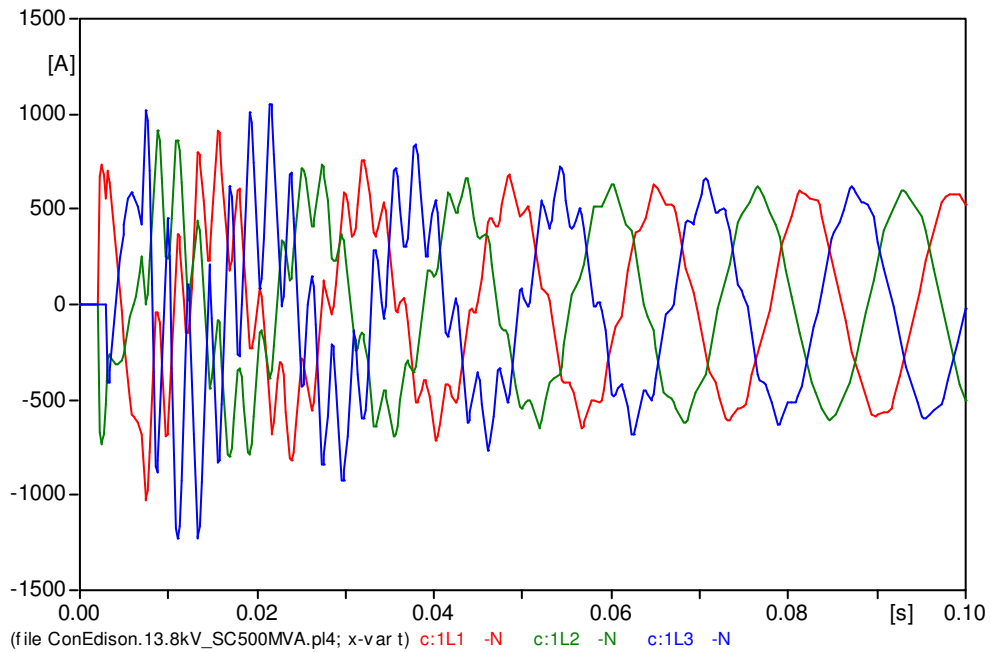

Bus Voltages with 8 Ohm Insertion Resistors

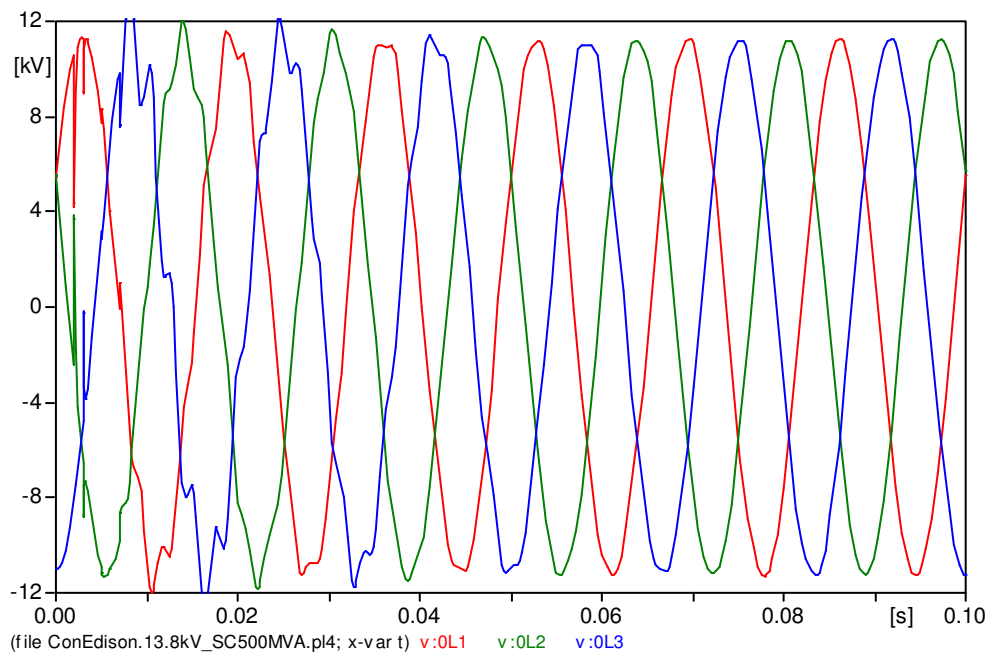

Comment

Capacitor currents indicate higher initial current peak if R too low (4 Ohms) or longer transient time if R too high (8 Ohms). Intermediate resistor value of 6 Ohms provides best combined performance. Voltage transients are not critical if insertion resistor within 4 to 8 Ohms.

3. Capacitor Bank 10 MVAR 13.8kV / 60Hz, 1000 MVA sc

Simulation Circuit

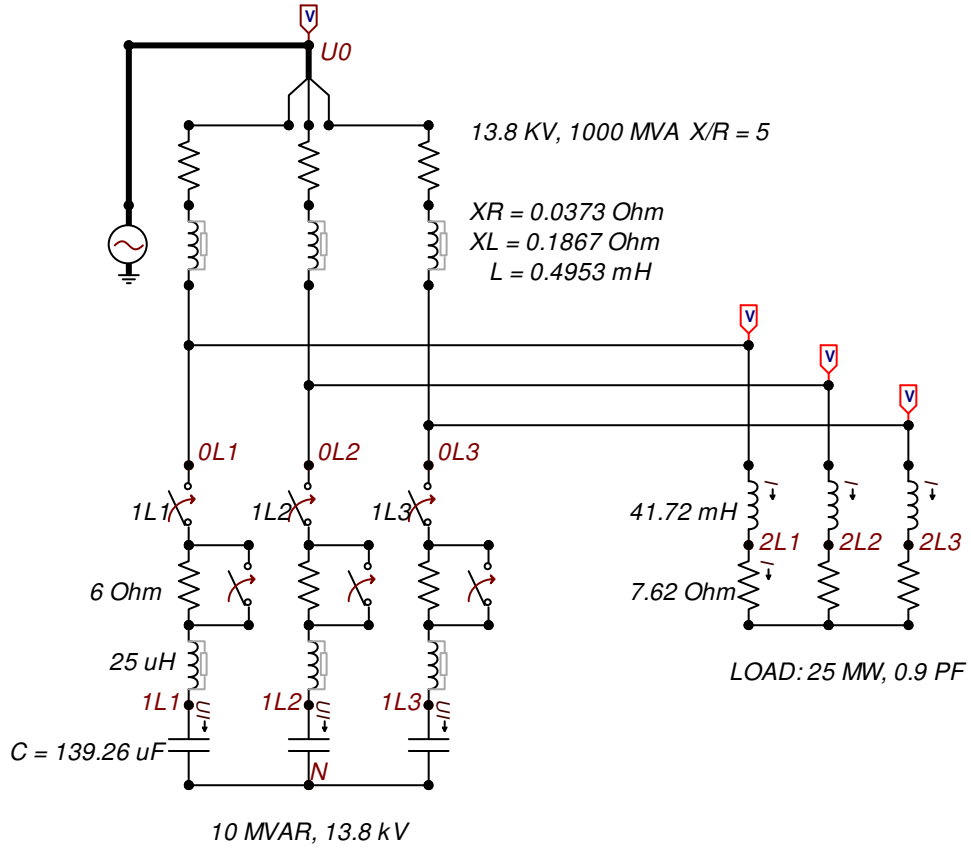

Results

Capacitor Currents without Insertion Resistors

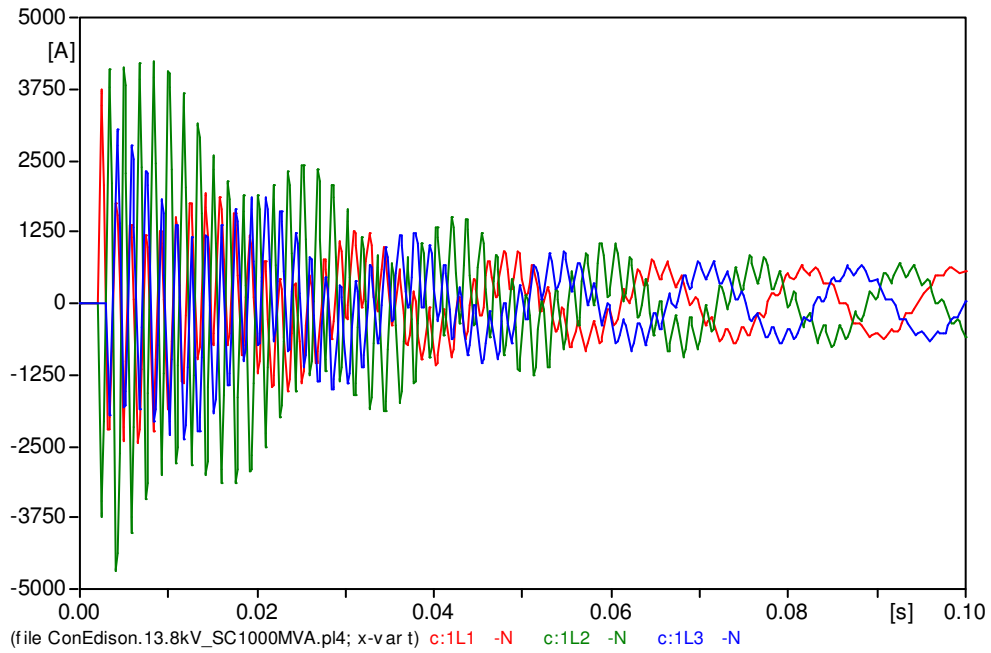

Bus Voltages without Insertion Resistors

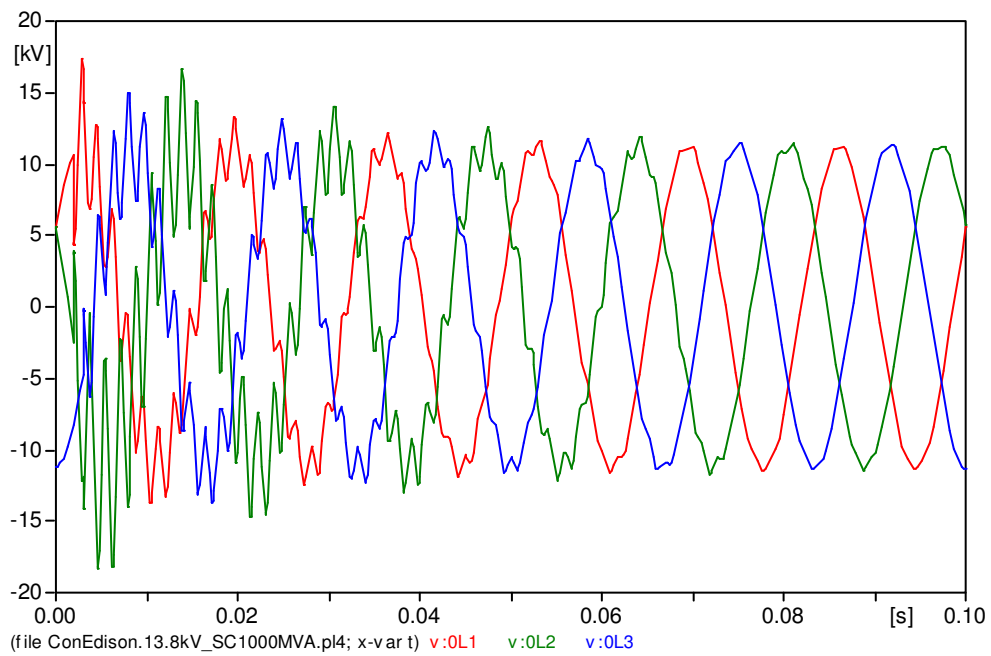

Capacitor Currents with 4 Ohm Insertion Resistors

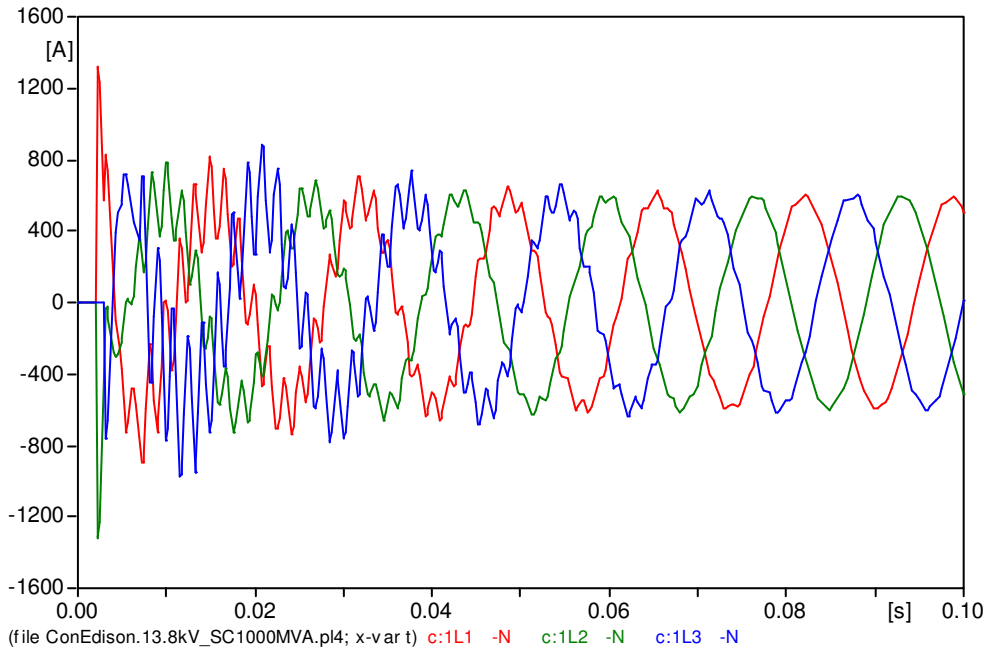

Bus Voltages with 4 Ohm Insertion Resistors

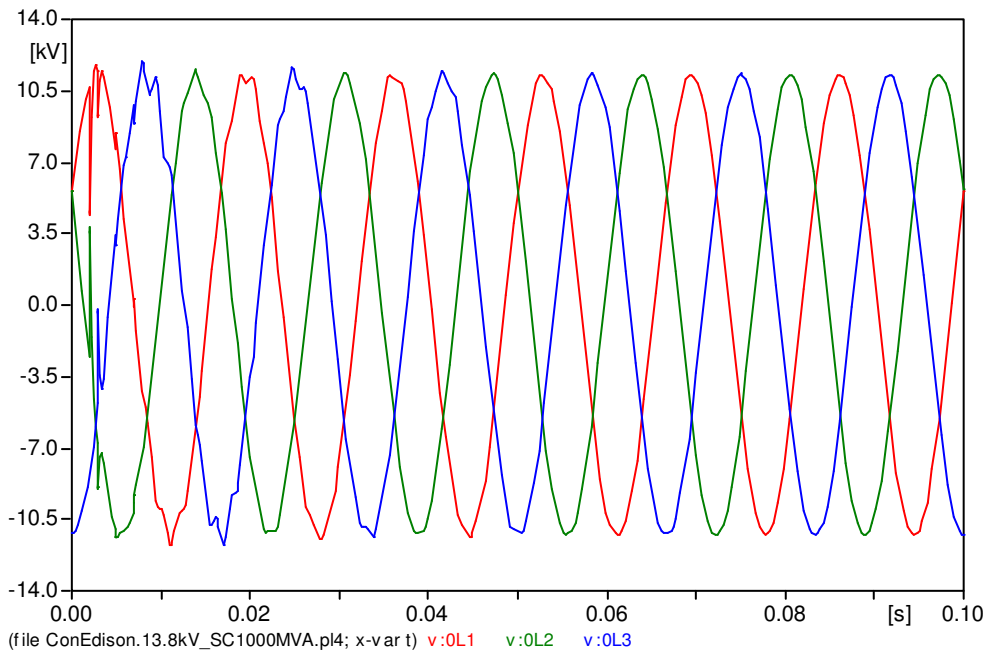

Capacitor Currents with 6 Ohm Insertion Resistors

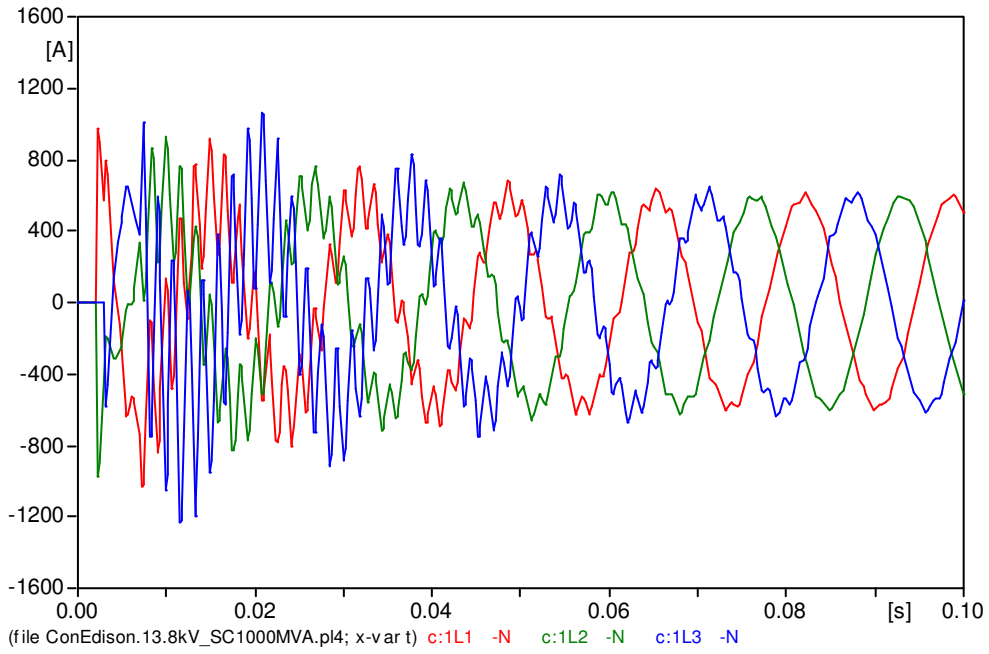

Bus Voltages with 6 Ohm Insertion Resistors

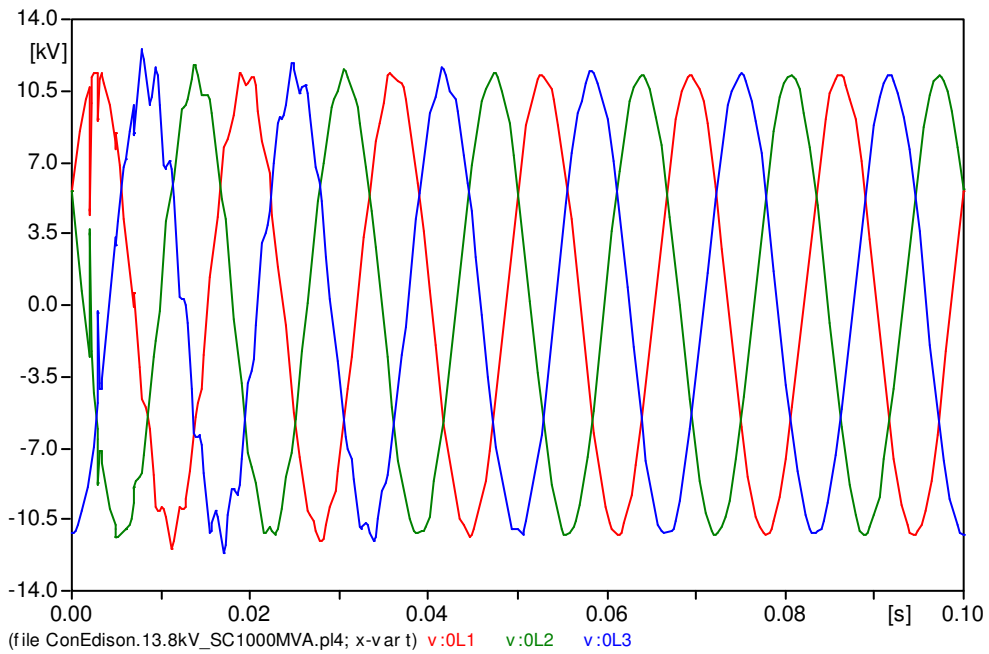

Capacitor Currents with 8 Ohm Insertion Resistors

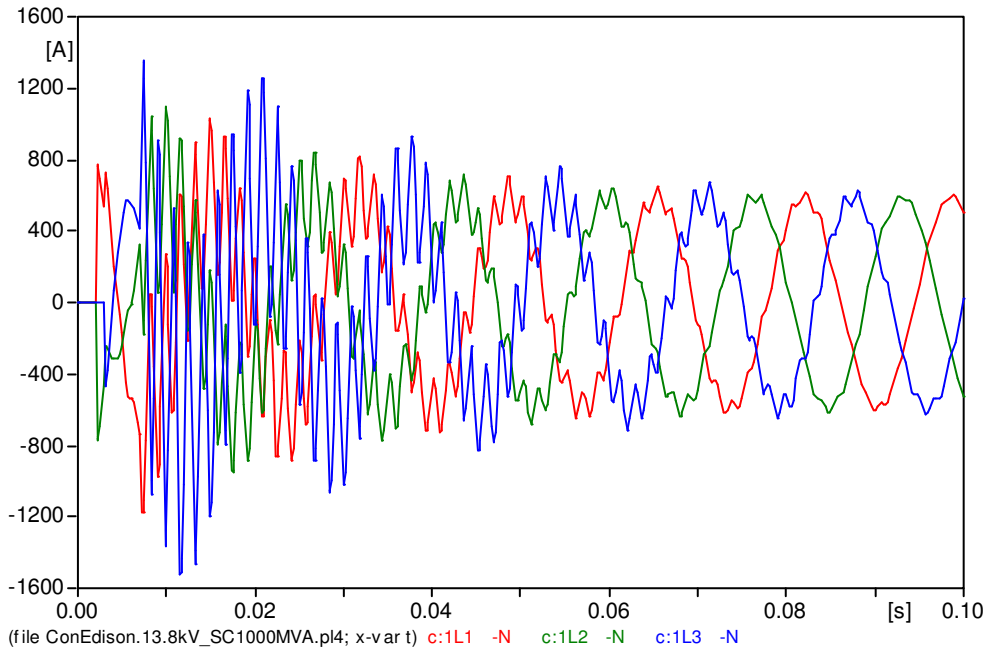

Bus Voltages with 8 Ohm Insertion Resistors

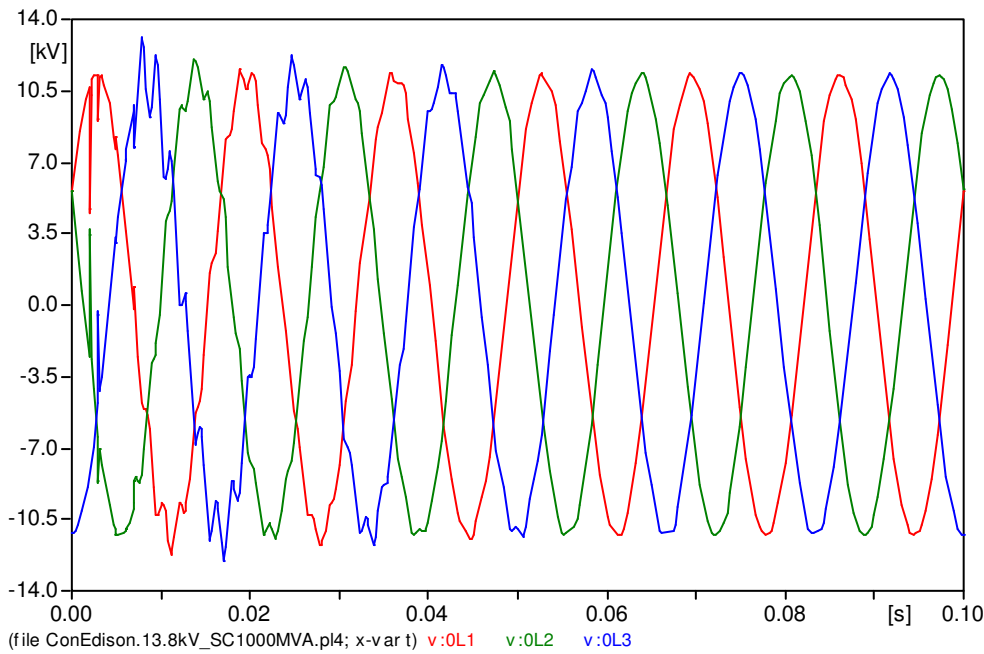

Comment

Capacitor currents indicate higher initial current peak if R too low (4 Ohms) or longer transient time if R too high (8 Ohms). Intermediate resistor value of 6 Ohms provides best combined performance. Voltage transients are not critical if insertion resistor within 4 to 8 Ohms.

4. Capacitor Bank 10 MVAR 25kV / 60Hz, 500 MVA sc

Simulation Circuit

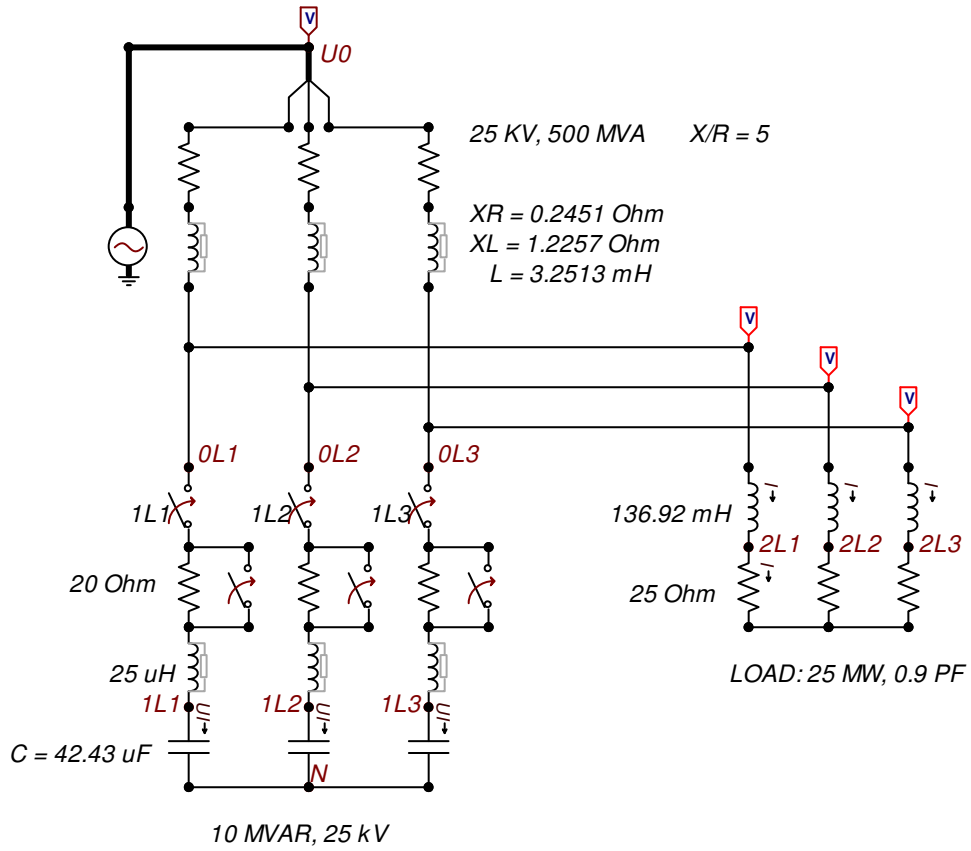

Results

Capacitor Currents without Insertion Resistors

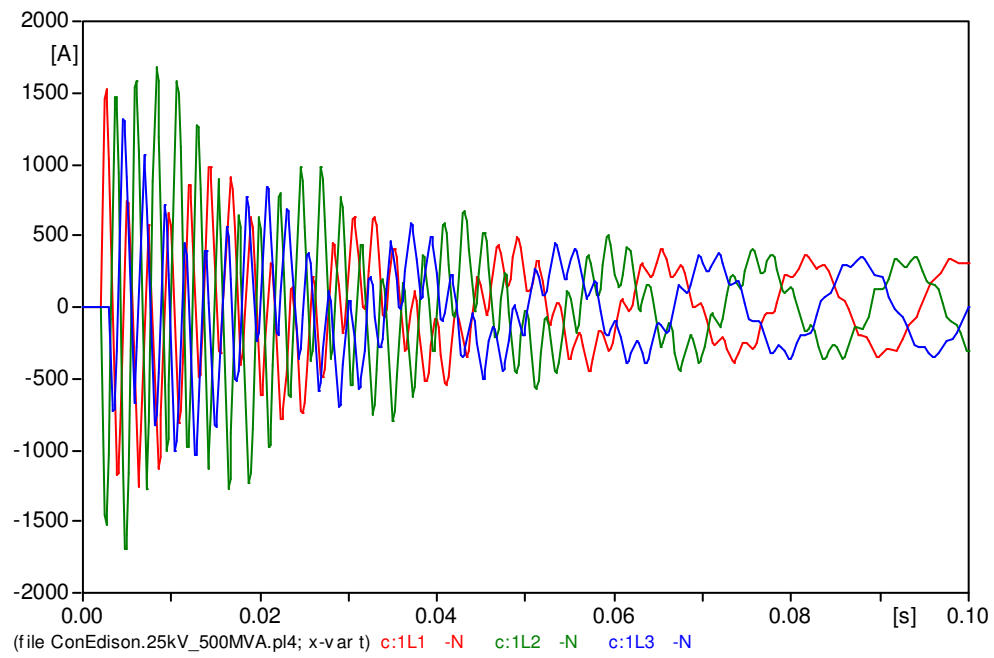

Bus Voltages without Insertion Resistors

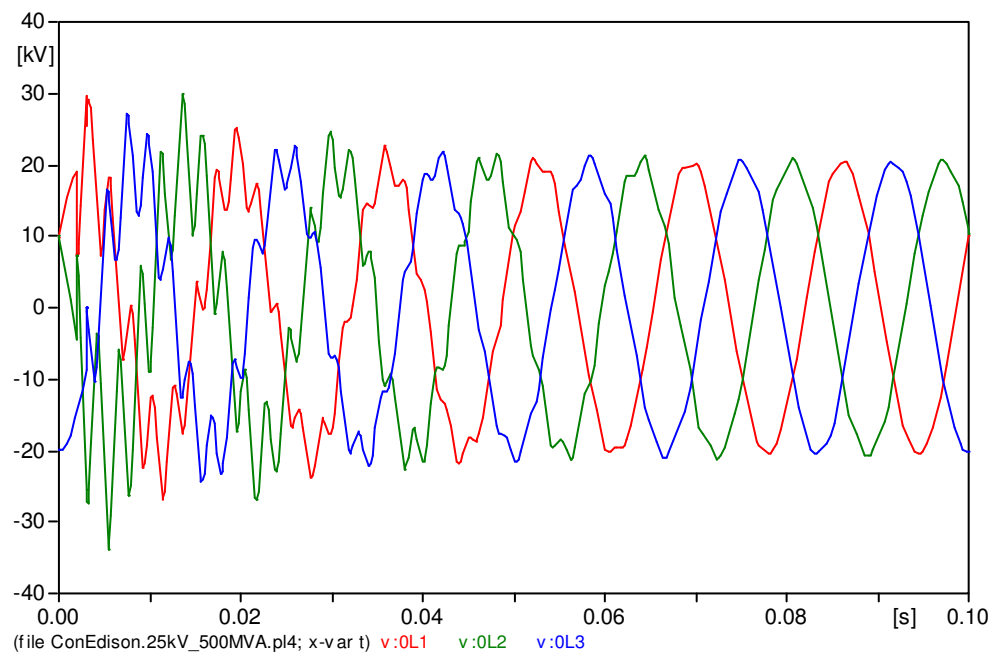

Capacitor Currents with 15 Ohm Insertion Resistors

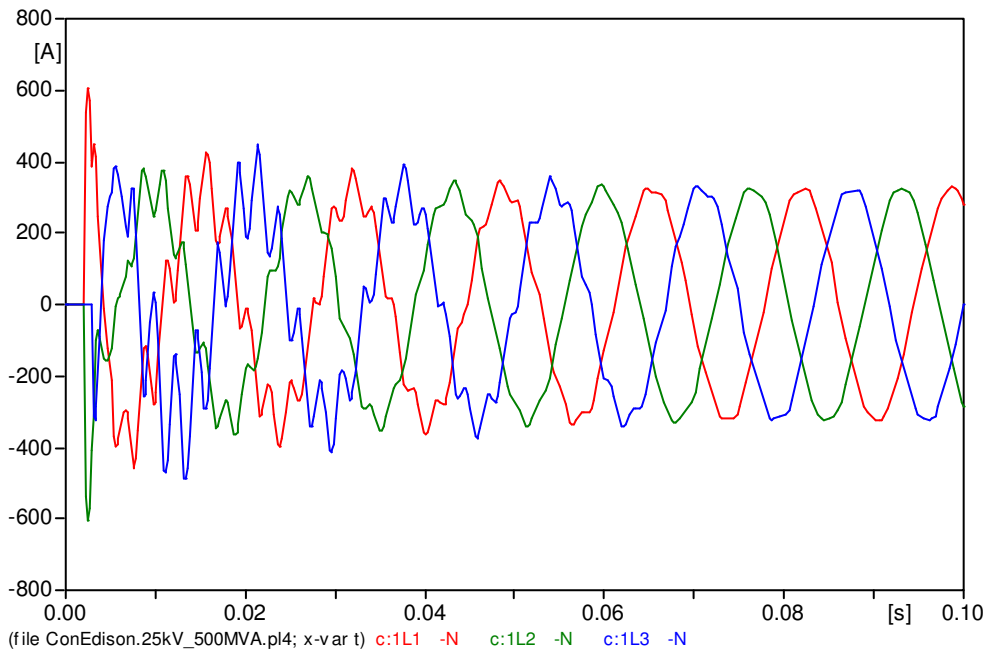

Bus Voltages with 15 Ohm Insertion Resistors

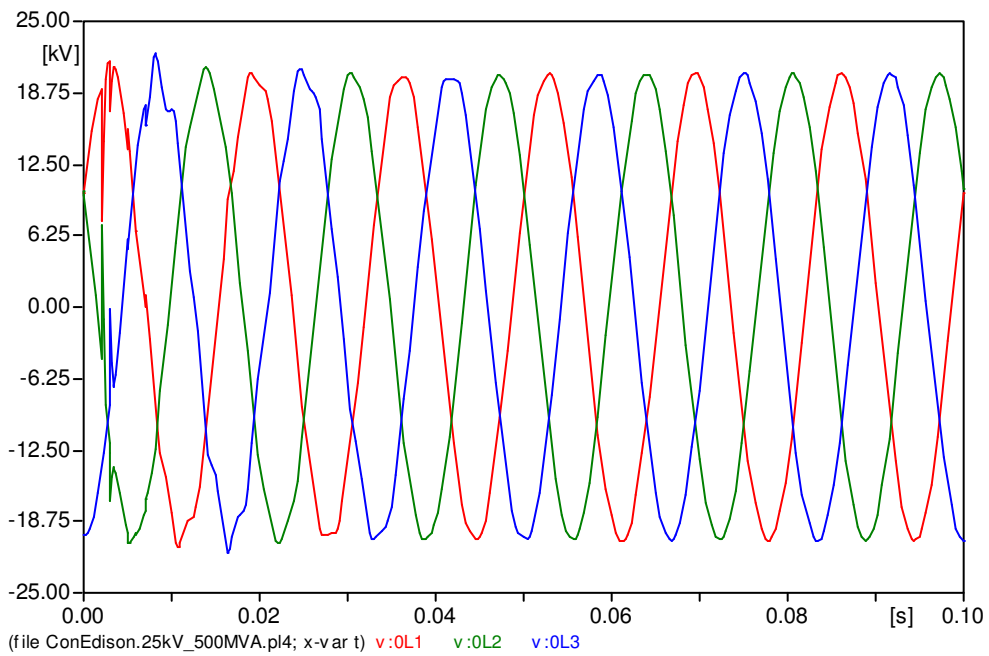

Capacitor Currents with 20 Ohm Insertion Resistors

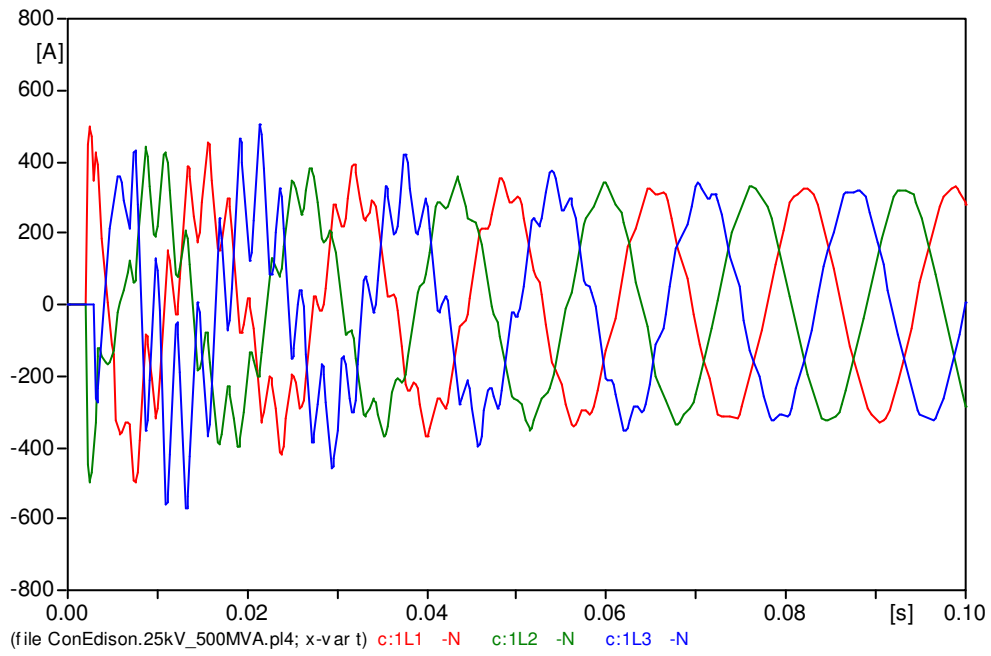

Bus Voltages with 20 Ohm Insertion Resistors

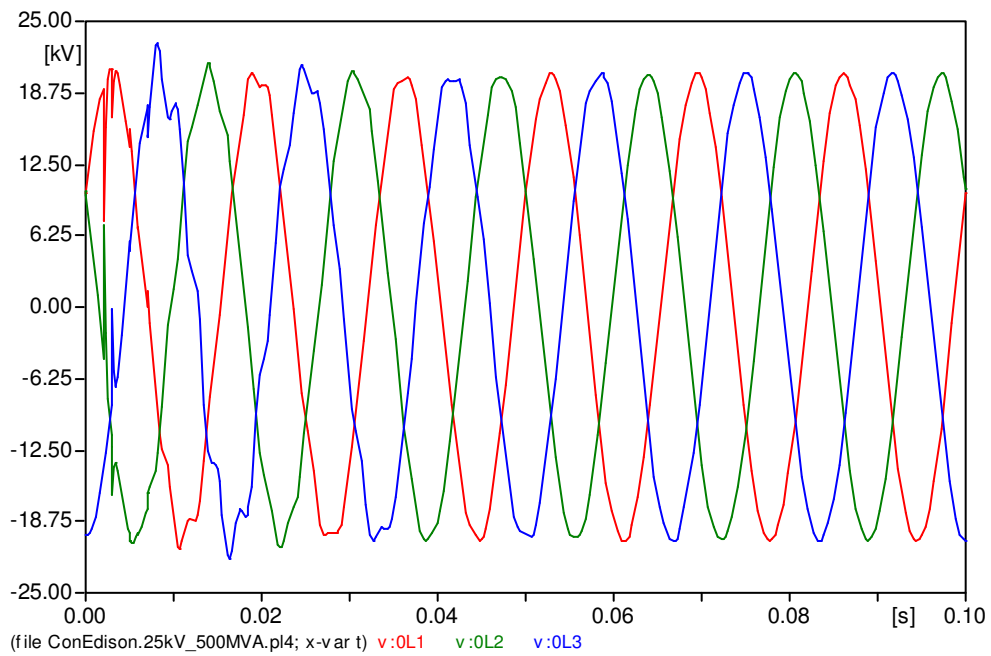

Capacitor Currents with 25 Ohm Insertion Resistors

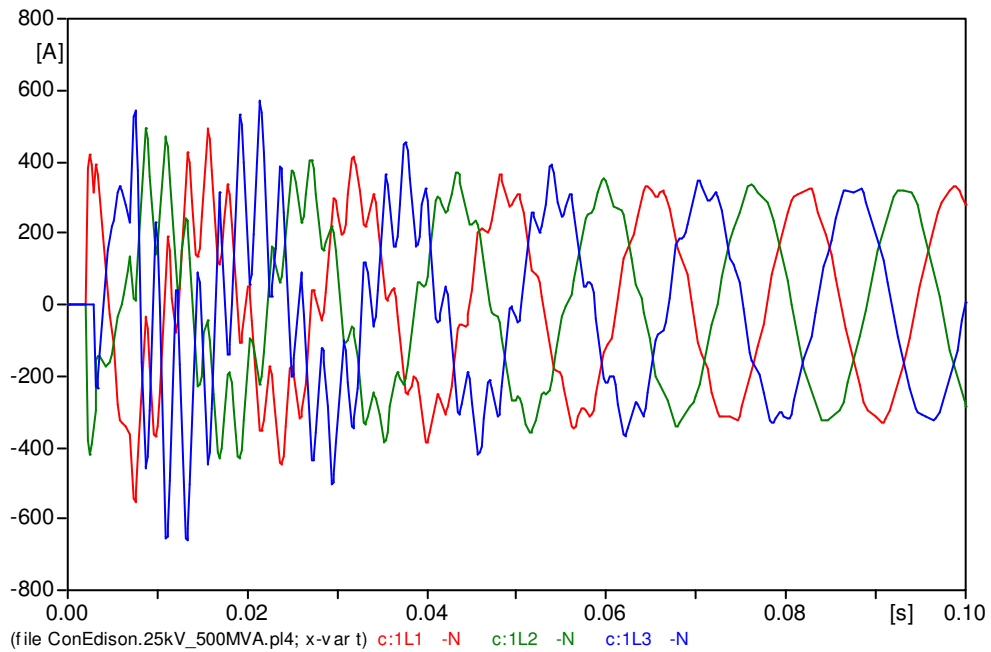

Bus Voltages with 25 Ohm Insertion Resistors

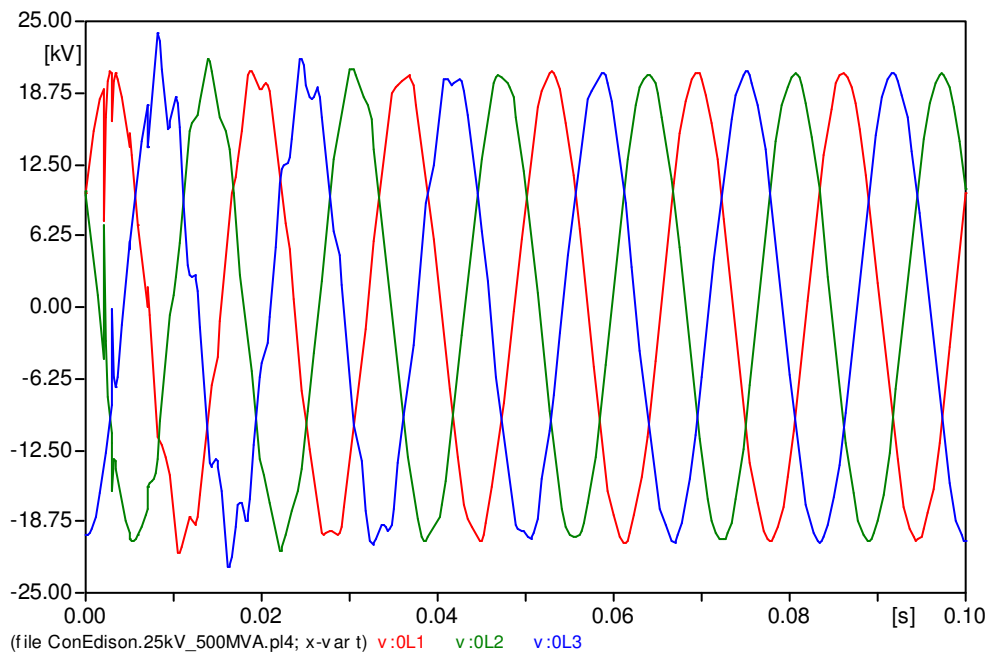

Comment

Capacitor currents indicate higher initial current peak if R too low (15 Ohms) or longer transient time if R too high (25 Ohms). Intermediate resistor value of 20 Ohms provides best combined performance. Voltage transients are not critical if insertion resistor within 15 to 25 Ohms.

5. Capacitor Bank 10 MVAR 25kV / 60Hz, 1000 MVA sc

Simulation Circuit

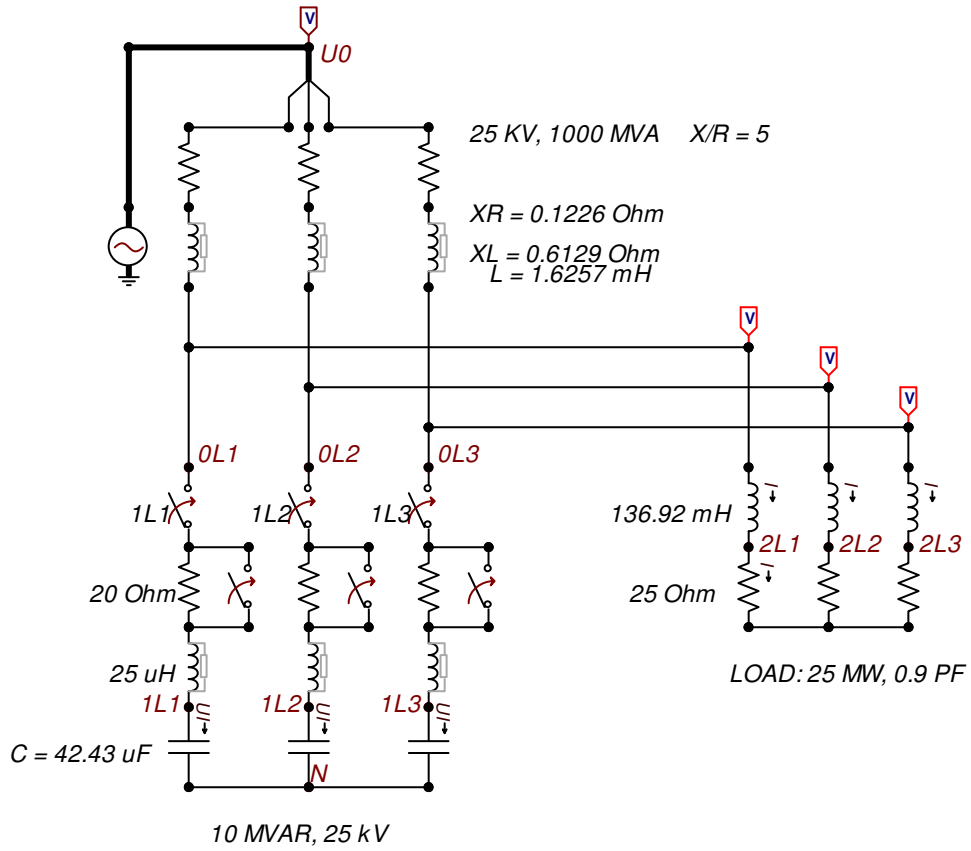

Results

Capacitor Currents without Insertion Resistors

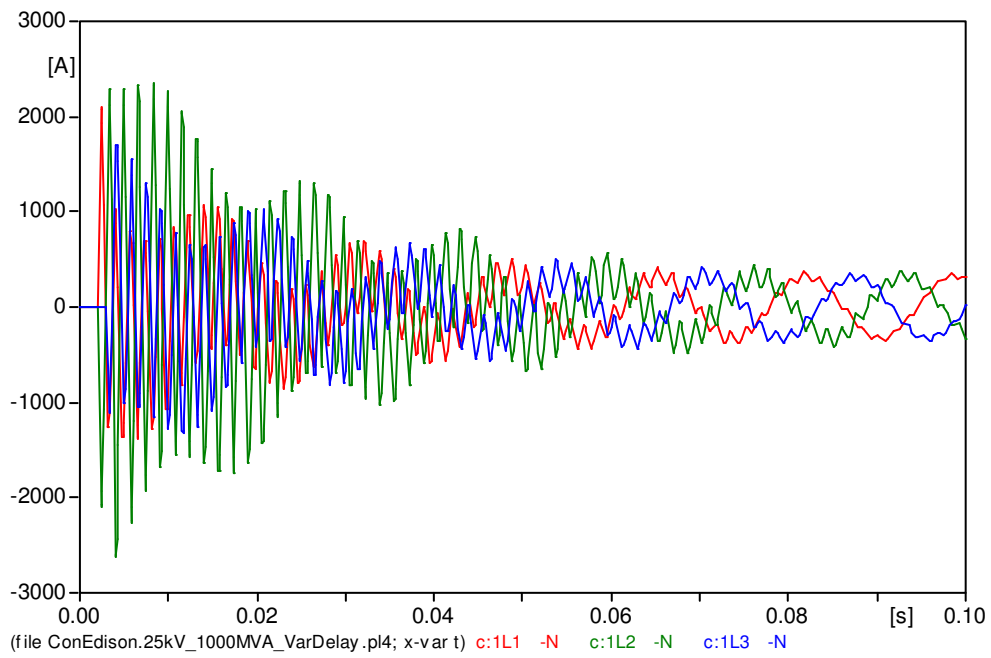

Bus Voltages without Insertion Resistors

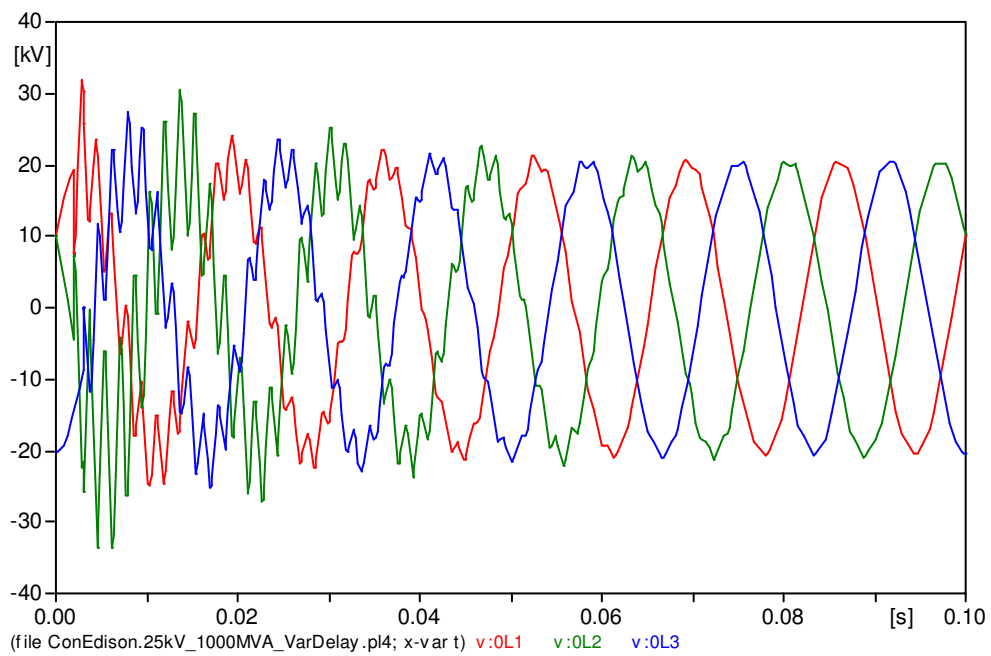

Capacitor Currents with 15 Ohm Insertion Resistors

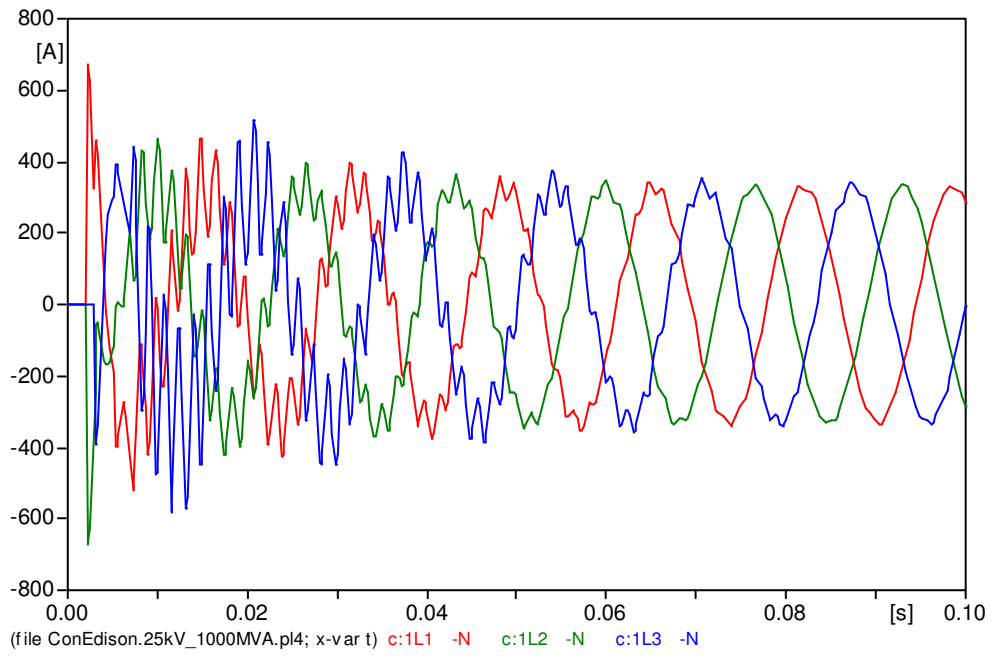

Bus Voltages with 15 Ohm Insertion Resistors

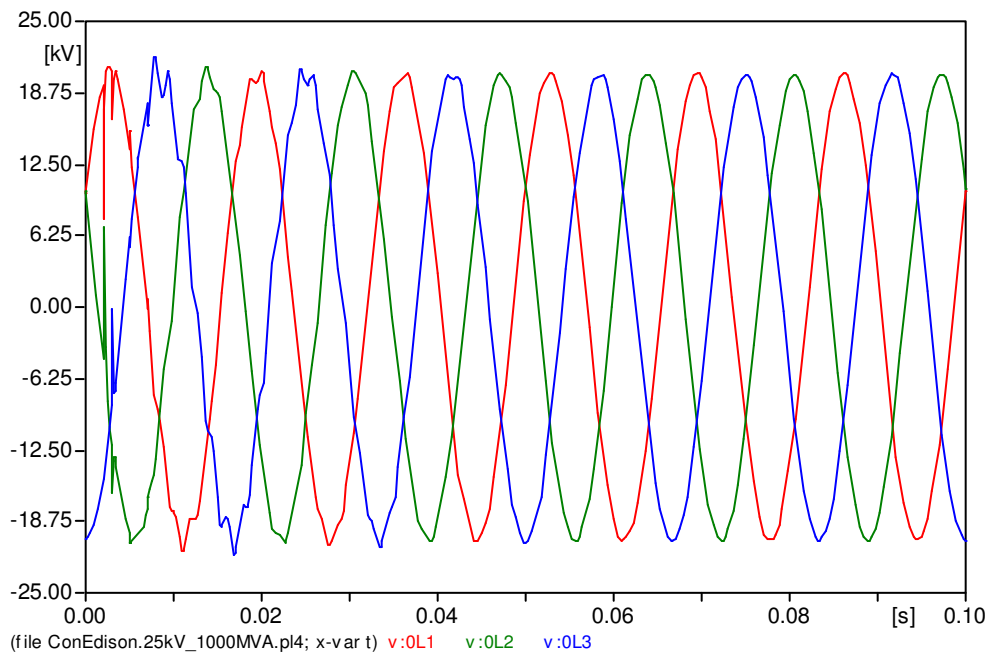

Capacitor Currents with 20 Ohm Insertion Resistors

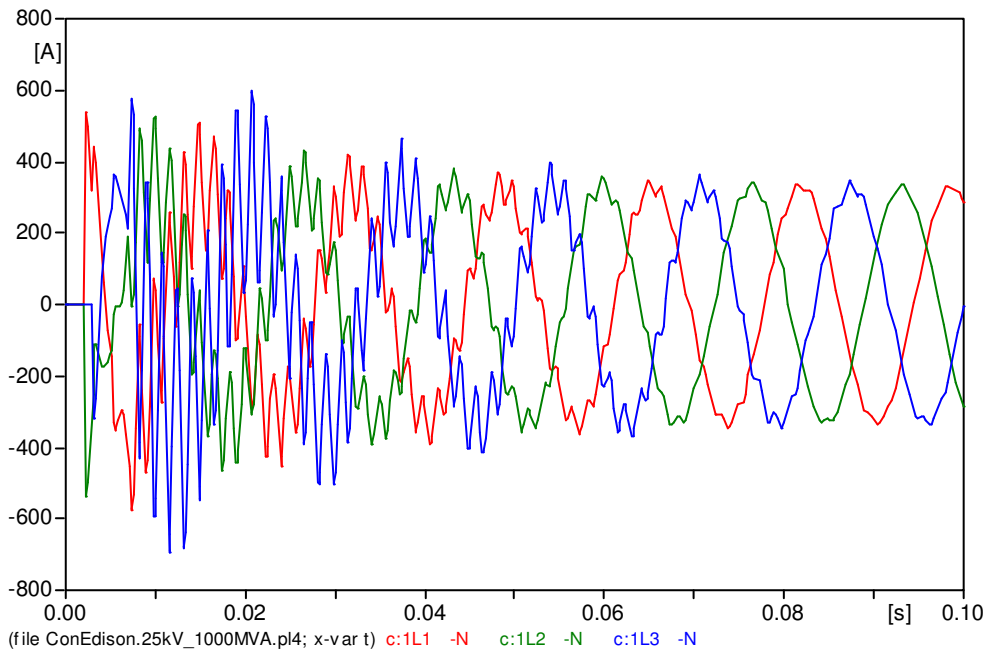

Bus Voltages with 20 Ohm Insertion Resistors

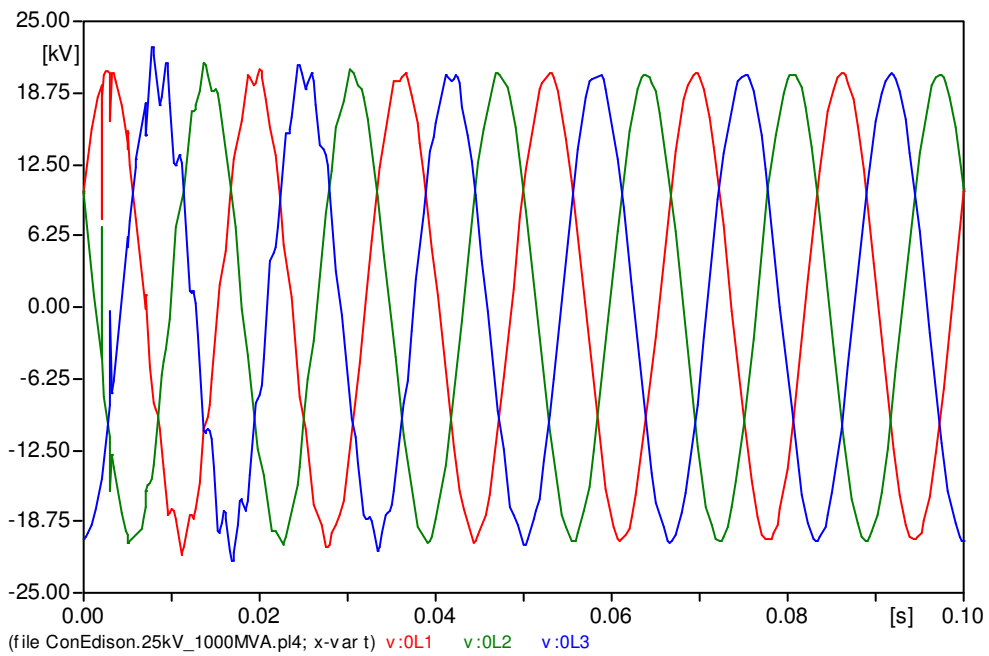

Capacitor Currents with 25 Ohm Insertion Resistors

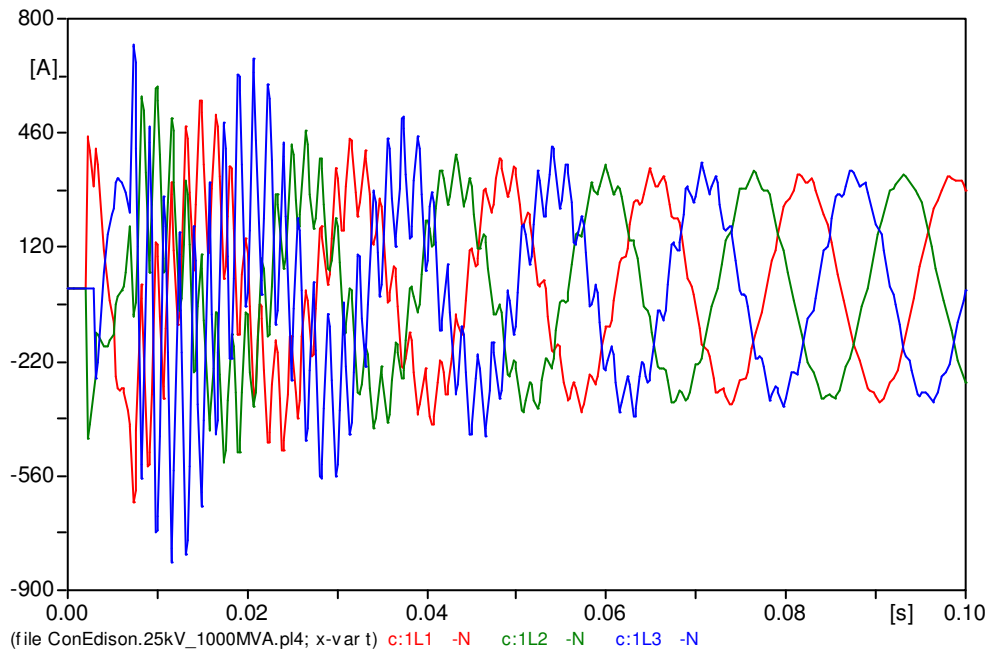

Bus Voltages with 25 Ohm Insertion Resistors

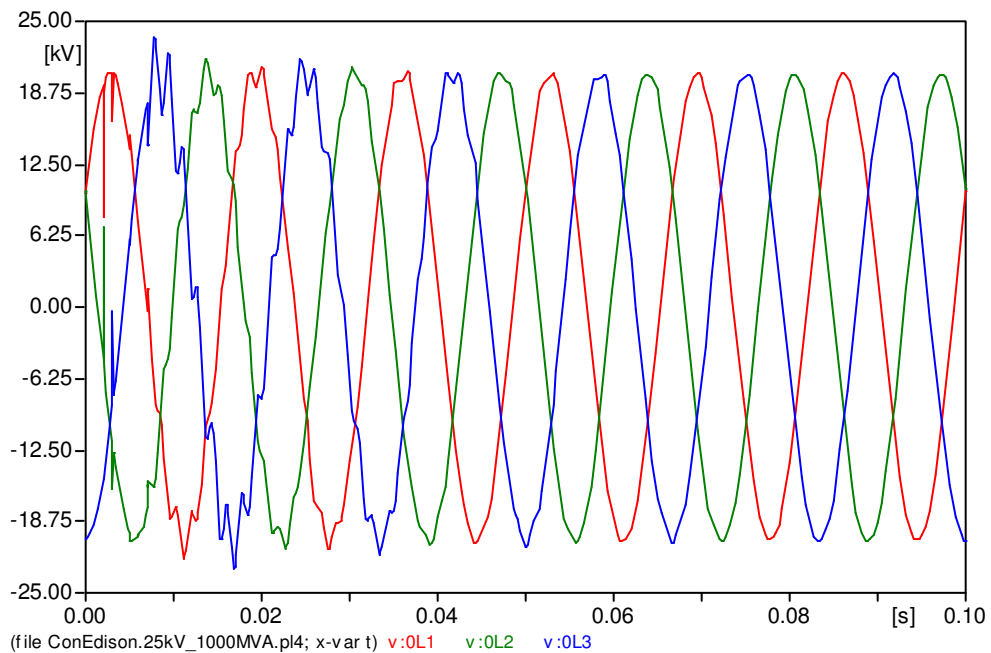

Comment

Capacitor currents indicate higher initial current peak if R too low (15 Ohms) or longer transient time if R too high (25 Ohms). Intermediate resistor value of 20 Ohms provides best combined performance. Voltage transients are not critical if insertion resistor within 15 to 25 Ohms.

6. Conclusions

Optimum resistor sizing for 13.8 kV: 6 Ohms

Optimum resistor sizing for 25 kV: 20 Ohms

These resistors will achieve the shortest current transients with minimum transient peak. Maximum transient peak current is less than 2 x rated peak current.

The incidence of the utility sc capacity was found minimal for the simulated range of 500 to 1000 MVA. Current transients settle almost completely within 100 ms.

Resistor tolerance is not critical: a variation of $\pm 20\%$ in resistor value will cause minimal impact on transients.

The incidence of the load on the current transients can be neglected. Simulation results without ac load do not differ noticeably from the results recorded with full load (25 MW at 0.9 PF).